

TA, TU 75WA24 Series Low Voltage Electronic Power Supply



Efficiency	>85%
Power Factor	>0.98
Case TC	90° Max.
Protection	Input/Output
Storage	-30°C/+90°C
Humidity	95% RH Max.
IP Rating	IP60
Class	IP65
Dimming	ELV Dimming



FEATURES

- No load technology, works with both Halogen & LED AC loads
- Isolated output power per NEC and UL safety requirements
- UL recognized/listed, meets UL 2108 requirements
- Auto-reset; Short circuit, Overload and Thermal protection
- Soft start
- ELV Dimmable 0% - 100%
- Low profile, small compact design to fit in most enclosures

MODEL SPECIFICATIONS

120V						
Model Number	Input Voltage	Wattage	Input Current	Output Voltage	Load Type	Form Factor
TA75WA24	120V AC 50/60Hz	75W	0.63A	24V AC	Incandescent & Halogen Bulbs	B2
TA75WA24LED		75W	0.63A	24V AC	AC LED Bulbs, Incandescent & Halogen Bulbs	B4
TA75WA24DL		75W	0.63A	24V AC	Incandescent & Halogen Bulbs	B4
TA75WA24LEDDL		75W	0.63A	24V AC	LED Bulbs, Incandescent & Halogen Bulbs	B4
TA75WA24LED65B15		75W	0.63A	24V AC	AC LED Bulbs, Incandescent & Halogen Bulbs	MB1
TA75WA24LED65B15D010		75W	0.63A	24V AC	AC LED Bulbs, Incandescent & Halogen Bulbs	MB2

120V Remote						
Model Number	Input Voltage	Wattage	Input Current	Output Voltage	Load Type	Form Factor
TA75WA24RE	120V AC 50/60Hz	75W	0.63A	24V AC	Incandescent & Halogen Bulbs	G2
TA75WA24REO		75W	0.63A	24V AC	Incandescent & Halogen Bulbs	G3
TA75WA24LEDRE		75W	0.63A	24V AC	AC LED Bulbs, Incandescent & Halogen Bulbs	G2
TA75WA24LEDREO		75W	0.63A	24V AC	AC LED Bulbs, Incandescent & Halogen Bulbs	G3
TA75WA24DLRE		75W	0.63A	24V AC	Incandescent & Halogen Bulbs	G2
TA75WA24DLREO		75W	0.63A	24V AC	Incandescent & Halogen Bulbs	G3
TA75WA24LEDDLRE		75W	0.63A	24V AC	LED Bulbs, Incandescent & Halogen Bulbs	G2
TA75WA24LEDDLREO		75W	0.63A	24V AC	LED Bulbs, Incandescent & Halogen Bulbs	G3
TA75WA24LED65B15RE		75W	0.63A	24V AC	AC LED Bulbs, Incandescent & Halogen Bulbs	G2
TA75WA24LED65B15REO		75W	0.63A	24V AC	AC LED Bulbs, Incandescent & Halogen Bulbs	G3
TA75WA24LED65B15D010RE		75W	0.63A	24V AC	AC LED Bulbs, Incandescent & Halogen Bulbs	G2
TA75WA24LED65B15D010REO		75W	0.63A	24V AC	AC LED Bulbs, Incandescent & Halogen Bulbs	G3

220-240V						
Model Number	Input Voltage	Wattage	Input Current	Output Voltage	Load Type	Form Factor
TU75WA24	220-240V AC 50/60Hz	75W	0.34A	24V AC	Incandescent & Halogen Bulbs	B4, B2
TU75WA24LED		75W	0.34A	24V AC	AC LED Bulbs, Incandescent & Halogen Bulbs	B4, B2
TU75WA24DL		75W	0.34A	24V AC	Incandescent & Halogen Bulbs	B4, B2
TU75WA24LEDDL		75W	0.34A	24V AC	AC LED Bulbs, Incandescent & Halogen Bulbs	B4, B2

220-240V Remote

Model Number	Input Voltage	Wattage	Input Current	Output Voltage	Load Type	Form Factor
TU75WA24RE	220-240V AC 50/60Hz	75W	0.34A	24V AC	Incandescent & Halogen Bulbs	G2
TU75WA24REO		75W	0.34A	24V AC	Incandescent & Halogen Bulbs	G3
TU75WA24LEDRE		75W	0.34A	24V AC	AC LED Bulbs, Incandescent & Halogen Bulbs	G2
TU75WA24LEDREO		75W	0.34A	24V AC	AC LED Bulbs, Incandescent & Halogen Bulbs	G3
TU75WA24DLRE		75W	0.34A	24V AC	Incandescent & Halogen Bulbs	G2
TU75WA24DLREO		75W	0.34A	24V AC	Incandescent & Halogen Bulbs	G3
TU75WA24LEDDLRE		75W	0.34A	24V AC	LED Bulbs, Incandescent & Halogen Bulbs	G2
TU75WA24LEDDLREO		75W	0.34A	24V AC	LED Bulbs, Incandescent & Halogen Bulbs	G3

MECHANICAL SPECS

FORM FACTOR	DIMENSIONS
B4 (standard)	2.7”(67.5mm) x 1.3”(33mm) x 0.8”(21mm)
B2	2.2”(56.5mm) x 1.3”(33mm) x 0.8”(21mm)
MB1	2.7”(68mm) x 1.6”(40mm) x 0.9”(22mm)
MB2	3.1”(72mm) x 1.6”(40mm) x 0.9”(22.1mm)
G2 (indoor)	9”(233.1mm) x 3.4”(85.5mm) x 2”(48.9mm)
G3 (outdoor)	11”(280mm) x 4”(103mm) x 2.2”(56mm)

B4

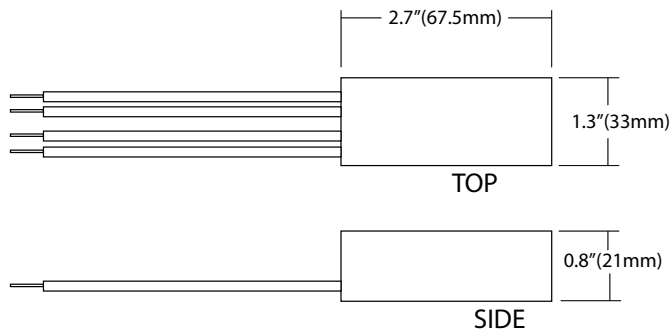

B2

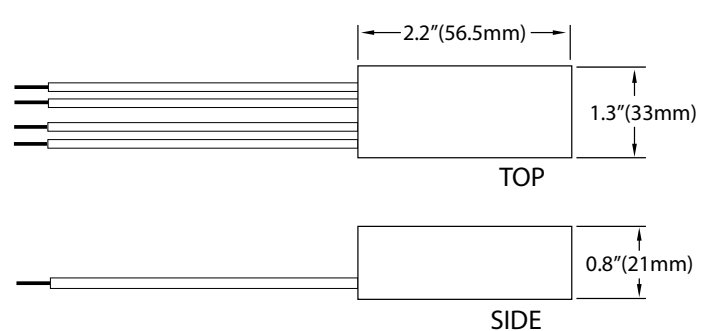

MB1

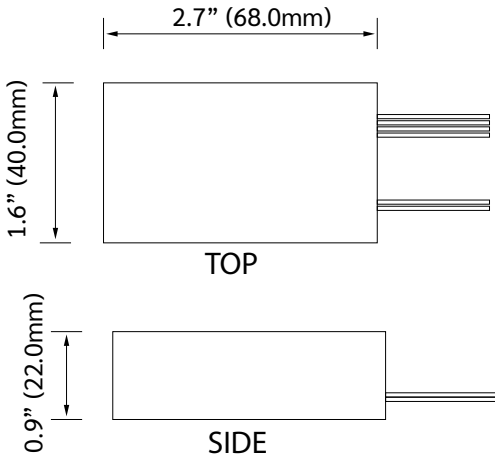

MB2

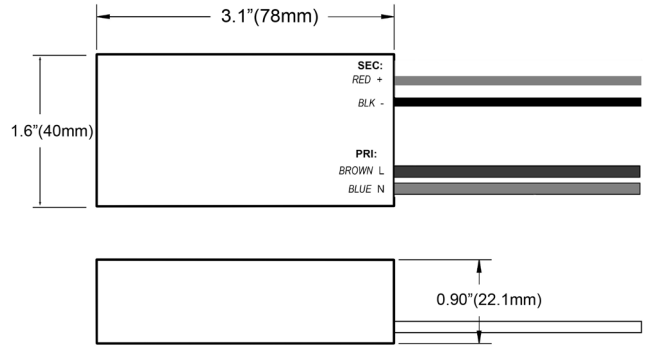

G2

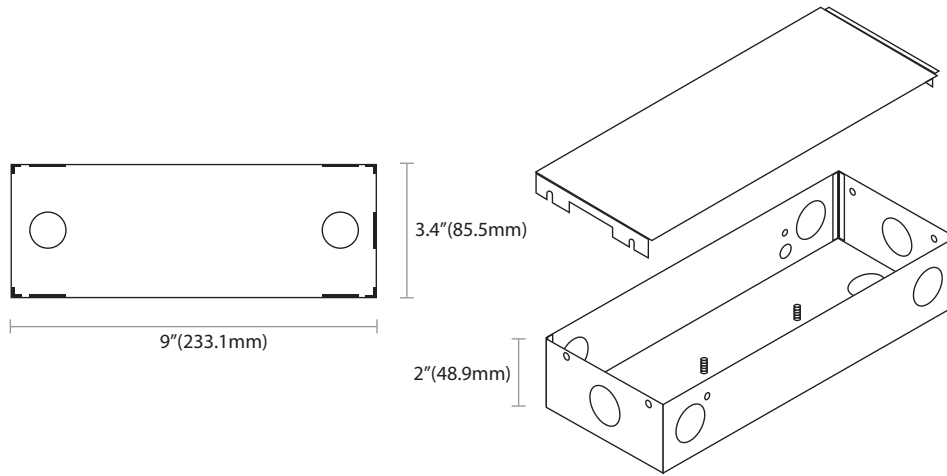

G3

