



L.T.F.

QLUX DOB AC Line Voltage LED Series



QLUXDOBAS7720W66LED9 20W 77mm Square LED Board

QLUX DOB



Wattage	20W
Power Factor	0.90
CRI	94
CCT Options	3000K, 4000K, Custom
Luminous Flux	≈ 1746 lm
Efficacy	≈ 86 lm/W
Number of LEDs	66
Beam Angle	160°
Dimensions	77mm x 77mm
Dimming	ELV, Triac & 0-10V

NOTE: Measurements based on 4000K CCT model.



RoHS



FEATURES

- Driver On Board technology - No external LED driver required.
- CCT options 3000K, 4000K, Custom
- Superior color rendering ≈ 94 CRI .
- High efficacy lumen output up to ≈ 86 lm/W.
- LM-80 compliant LEDs.
- Tight binning 3 step Mac Adam Ellipses.
- Uniform & crisp light source intensity.
- Hot spot free design.
- California Title 24 Compliant.

- Extra thin low profile.
- Low heat generation, easy thermal management.
- Easy to fit in new design or retrofit applications.
- 277V AC option available.
- L70 > 60,000 Hours.

APPLICATIONS

- Residential and Commercial
- New or Retrofit OEM Fixtures



ELECTRICAL SPECIFICATIONS

Model #	Input	Wattage	CCT Options	Luminous Flux
QLUXDOBAS7720W66LED930	120V AC 0.21A 50/60Hz	20W	3000K	≈ 1700 lm
QLUXDOBAS7720W66LED940			4000K	≈ 1746 lm



L.T.F.

QLUX DOB AC Line Voltage LED Series



**QLUXDOBAS7720W66LED9
20W 77mm Square LED Board**

SPECTRORADIOMETRIC CHARACTERISTICS - 4000K

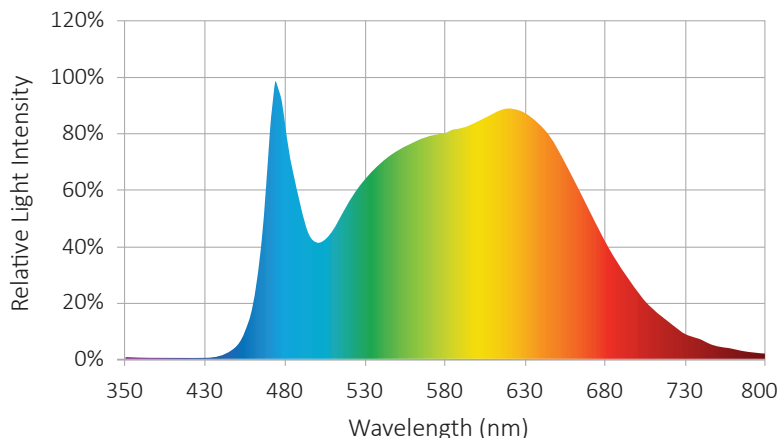

Luminous Flux: 1746.15 lm
Radiant Flux: 6.227 W
Efficacy: 85.8 lm/W
Nominal CCT: ANSI_F4000K
 $x_0=0.3800$ $y_0=0.3800$
Chromaticity Coordinates:
 $x=0.3836$ $y=0.3810$ $u'=0.2255$ $v'=0.5039$
Chromaticity Difference: +0.00106 Duv
CCT: 3946 K

CRI TEST RESULTS - 4000K

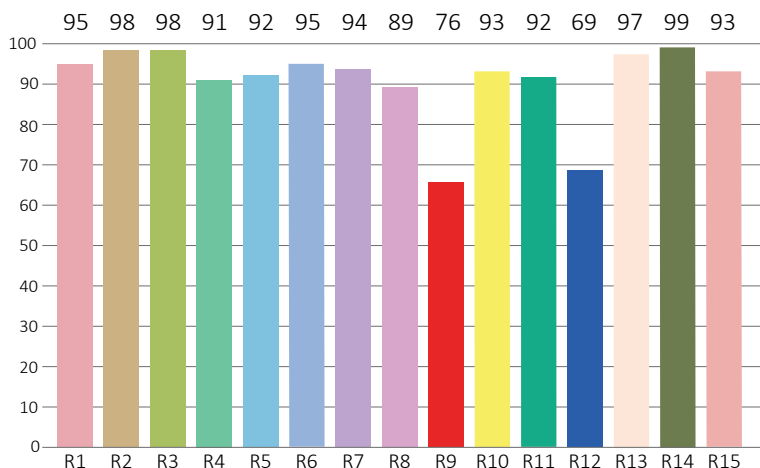

Color Rendering Index (CRI): 94.1
Dominant Wavelength: 577.0 nm(E)
Peak Wavelength: 455nm
Colour Fidelity Index: Rf=87
Gamut Index: Rg=96
Color Purity: 0.2949
Color Ratio: Kr=37.5% Kg=51.8% Kb=10.7%
Bandwidth: 32.2 nm
Photosynthetically Active Radiation (PAR): 5.91W
Photosynthetic Photon Flux (PPF): 28.39 $\mu\text{mol/s}$

R1=95	R2=98	R3=98	R4=91	R5=92	R6=95	R7=94	R8=89
R9=76	R10=93	R11=92	R12=69	R13=97	R14=99	R15=93	Re=91



L.T.F.

QLUX DOB AC Line Voltage LED Series



**QLUXDOBAS7720W66LED9
20W 77mm Square LED Board**

IES TM-30-18 Test Results - 4000K

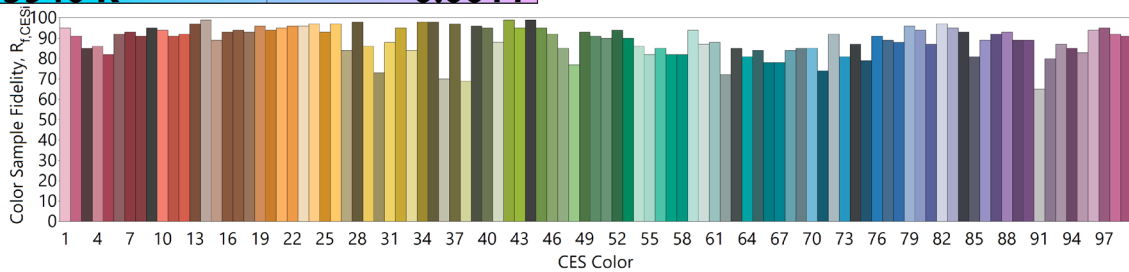
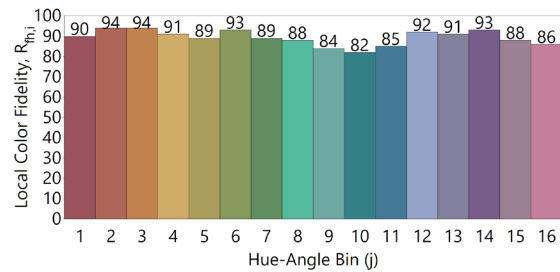
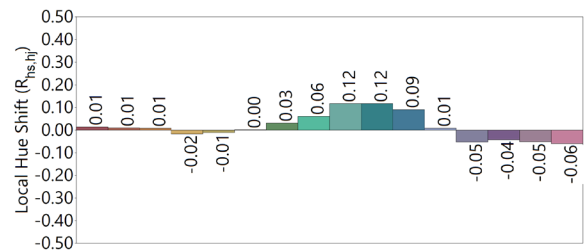
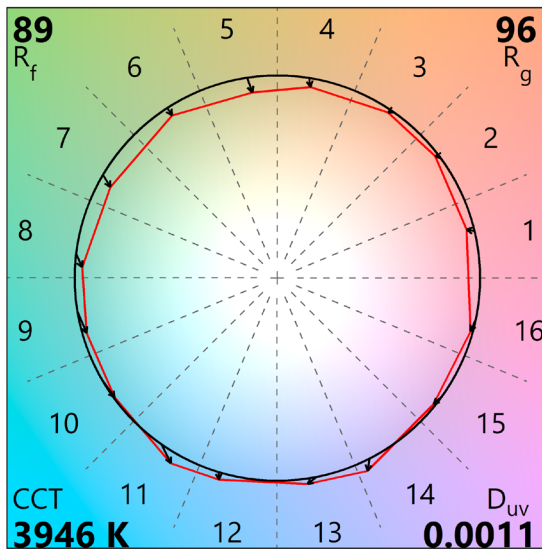
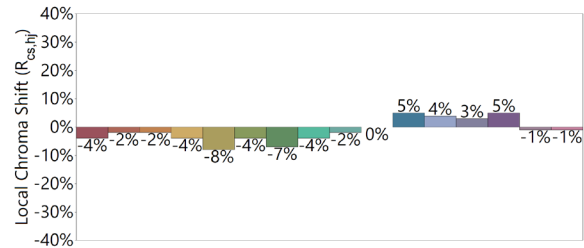
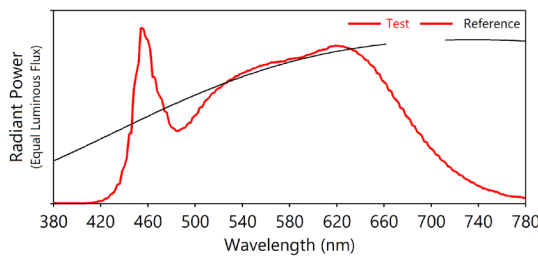



ABSOLUTE MAXIMUM RATINGS (Ta=25°C)

Parameter	Symbol	Value	Unit
Voltage	V in	132	Vac
Operating Temperature	---	-35~+50	°C
LED Solder Temperature	Ts	110	°C
Storage Temperature	Tstg	-40~+100	°C
ESD Sensivity (HBM)	---	±4000	V
Surge	---	2500	Vac

MECHANICAL SPECIFICATIONS

LED Board Dimensions
76.8mm x 77.2mm

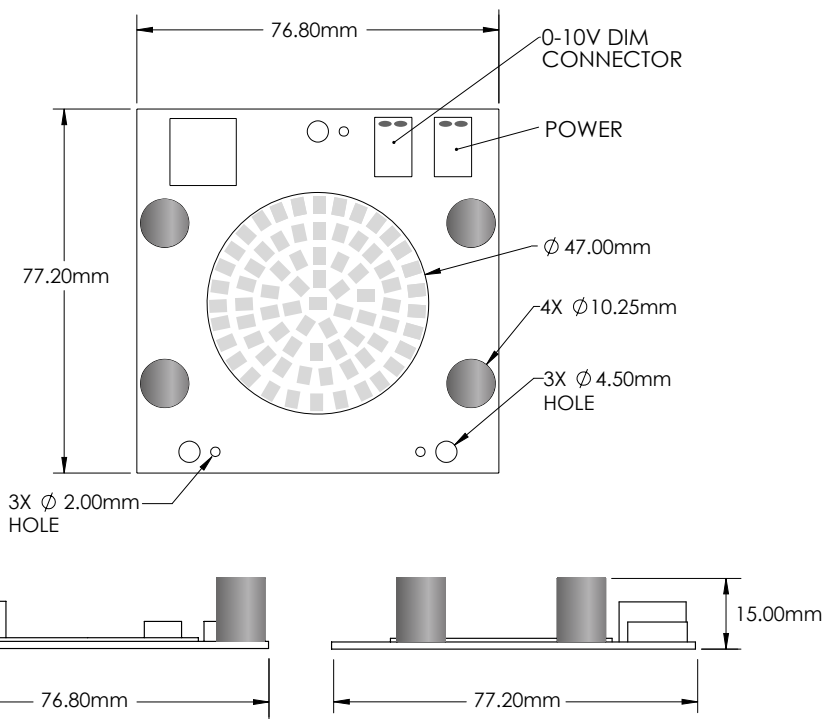

FLICKER CHARACTERISTICS

Dimmer	Flux Output Percentage	Percent Flicker
DVCL153P	100%	1.92%
DVCL153P	20%	13.4%