



L.T.F.

High CRI Chip on Board LED

**COBI 1512 12W Single CCT COB
QLUXCOBI15129030 & QLUXCOBI15129027**

QLUX COB



Typical Lumens	≈ 1200lm
Typical Wattage	12W
CRI / R9	98 / 89+
Available CCT	3000K, 2700K
Dimming	CCR; constant current reduction



RoHS



FEATURES

- Precise light output with no additional need for complicated control system or multiple optics
- High color rendering index (CRI) Ra max. 98, R9 89+
- LM-80 compliant LEDs
- Tight binning 3 step Mac Adam Ellipses
- Uniform and crisp light source intensity
- Exceeds ENERGY STAR lumen maintenance requirements
- Extra thin low profile
- Low heat generation, easy thermal management
- Easy to fit in new design or retrofit applications

APPLICATIONS

For architectural, residential, hospitality, retrofit, and general lighting fixtures.

- Spot lighting
- Down lighting
- Recessed can lighting
- Ceiling lighting
- Wall sconces
- Table lamps
- Pendants
- Track heads

GENERAL SPECIFICATIONS

Model	Wattage	CCT	Ra	R9	Luminous Flux
QLUXCOBI15129030	12W	3000K	98	93	1245 lm*
QLUXCOBI15129027		2700K	98	89	1271 lm*

* at 350mA

COMPATIBLE LTF LED DRIVERS

Model #	Input Voltage	Input Current	Output Voltage	Output Current	Dimming
DA15W350C1042-3001	120V AC 50/60Hz	0.125 A	10-42V DC	350mA	Triac/ELV
DA15W350C1842D010	120V AC 50/60Hz	0.125 A	18-42V DC	350mA	Triac/ELV/ 0-10V
DE15W350C1842D010	277V AC 50/60Hz	0.054 A	18-42V DC	350mA	Triac/ELV/ 0-10V
DS15W350C1042UD	100-305V AC 50/60Hz	0.15 A	10-42V DC	350mA	Triac/ELV/ 0-10V
DL115W350C	12V AC/DC 50/60Hz	0.05 A	18-42V DC	350mA	ELV / Magnetic ELV
DL215W350C	24V AC/DC 50/60Hz	0.05 A	18-42V DC	350mA	ELV / Magnetic ELV



L.T.F.

High CRI Chip on Board LED

**COBi 1512 12W Single CCT COB
QLUXCOBI15129030**



SPECTRORADIOMETRIC CHARACTERISTICS - 3000K

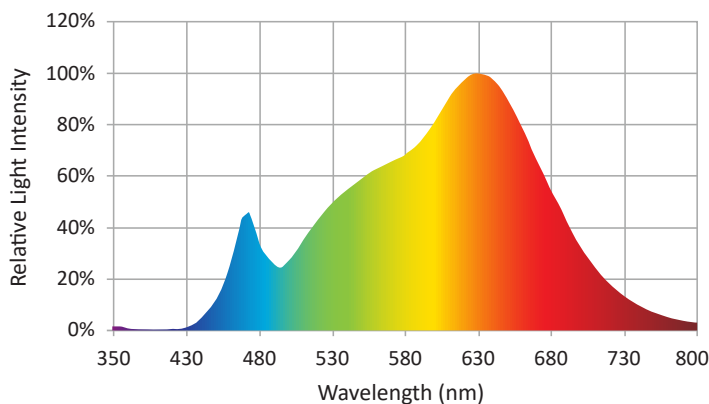

Luminous Flux: 1244.69
Radiant Flux: 4664mW
Efficacy: 94.3 lm/W
Nominal CCT: LED_3000K
 x0=0.4338 y0=0.4030
Chromaticity Coordinates:
 x=0.4252 y=0.3943 u'=0.2472 v'=0.5157
Chromaticity Difference: -0.00226Duv
CCT: 3127K

CRI TEST RESULTS - 3000K

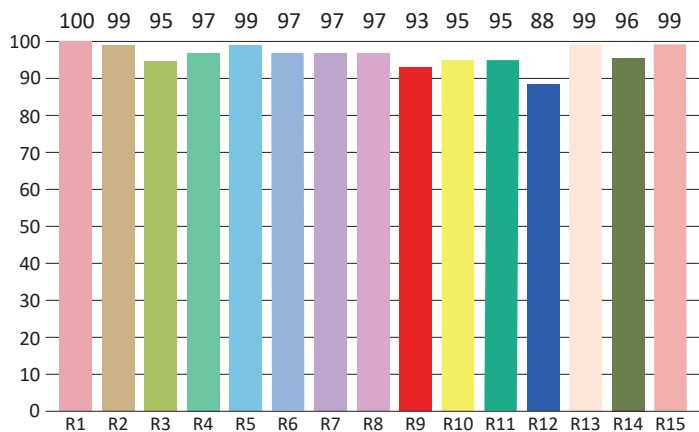

Color Rendering Index (CRI): Ra=97.6
Dominant Wavelength: 582nm
Peak Wavelength: 630nm
Colour Fidelity Index: Rf=94
Gamut Index: Rg=103
Color Purity: 0.4604
Color Ratio: Kr=42.3% Kg=48.9% Kb=8.8%
Bandwidth: 178.2nm

R1=100	R2=99	R3=95	R4=97	R5=99	R6=97	R7=97	R8=97
R9=93	R10=95	R11=95	R12=88	R13=99	R14=96	R15=99	Re=96

* Test result shown based on 3000K CCT



L.T.F.

High CRI Chip on Board LED

**COBi 1512 12W Single CCT COB
QLUXCOBi15129027**



SPECTRORADIOMETRIC CHARACTERISTICS - 2700K

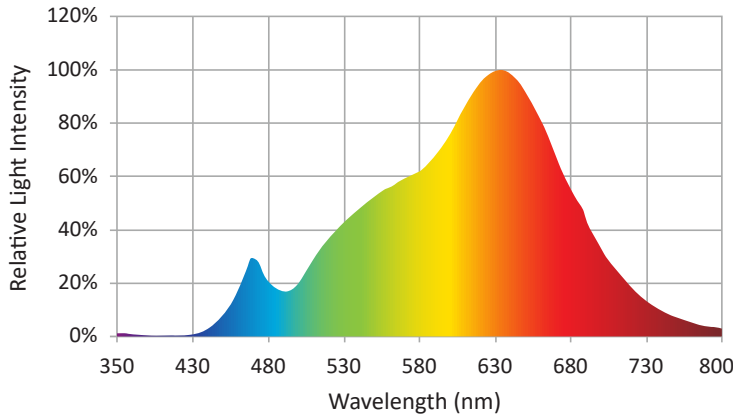

Luminous Flux: 1244.69 lm
Radiant Flux: 4685 mW
Efficacy: 96.4 lm/W
Nominal CCT: LED_2700K
 x0=0.4578 y0=0.4101
Chromaticity Coordinates:
 x=0.4513 y=0.4087 u'=0.2578 v'=0.5253
Chromaticity Difference: +0.00008Duv
CCT: 2809K

CRI TEST RESULTS - 2700K

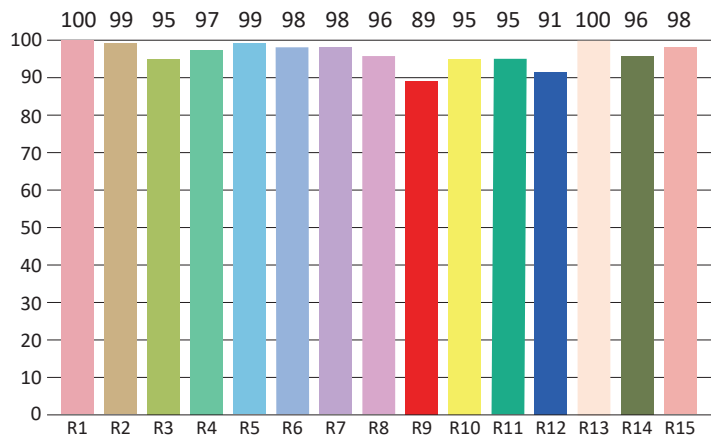

Color Rendering Index (CRI): Ra=97.8
Dominant Wavelength: 582 nm
Peak Wavelength: 630 nm
Colour Fidelity Index: Rf=95
Gamut Index: Rg=101
Color Purity: 0.4604
Color Ratio: Kr=44.7% Kg=47.4% Kb=7.8%
Bandwidth: 161 nm

R1=100	R2=99	R3=95	R4=97	R5=99	R6=98	R7=98	R8=96
R9=89	R10=95	R11=95	R12=91	R13=100	R14=96	R15=98	Re=97

* Test result shown based on 2700K CCT



L.T.F.

High CRI Chip on Board LED



**COBi 1512 12W Single CCT COB
QLUXCOBI15129030 & QLUXCOBI15129027**

ABSOLUTE MAXIMUM RATINGS (Ta=25°C)

	Symbol	Absolute Maximum Rating	Unit
Forward Current	If	420	mA
Peak Power	P	16.9	W
Reverse Voltage	vr	-15	V
Operating Temperature	TOPR	-30~+100	°C
Storage Temperature	Tstg	-40~100	°C
Hand soldering condition	Tsld	3.5sec@350°C	sec
Case Temperature	Tc	100	°C
LED Junction Temperature	Tj	125	°C
Temperature of central silicon surface	Ts	125@IRDA Test	°C

**FORWARD CURRENT
VS. FORWARD VOLTAGE**

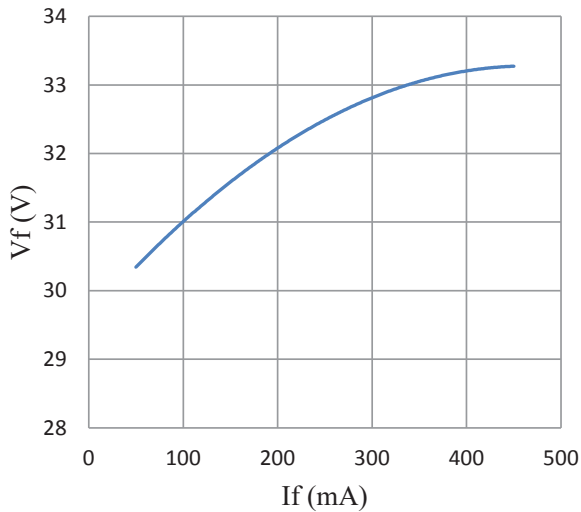

**FORWARD CURRENT
VS. RELATIVE LUMINOUS FLUX**

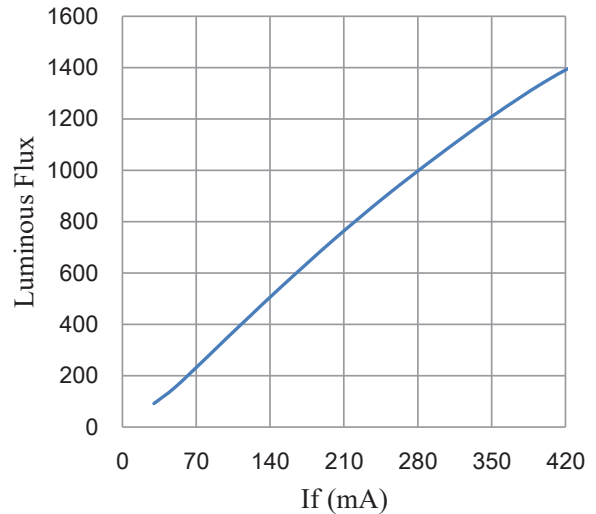



L.T.F.

High CRI Chip on Board LED



**COBi 1512 12W Single CCT COB
QLUXCOBI15129030 & QLUXCOBI15129027**

TYPICAL SPATIAL DISTRIBUTION

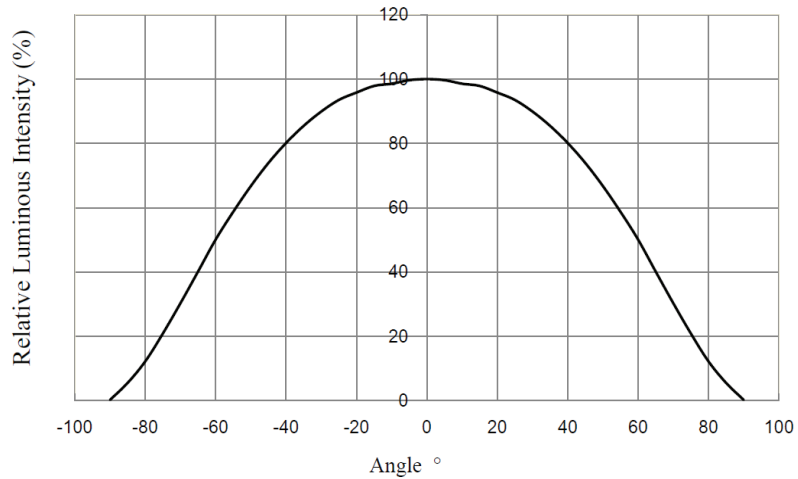

MECHANICAL SPECIFICATIONS

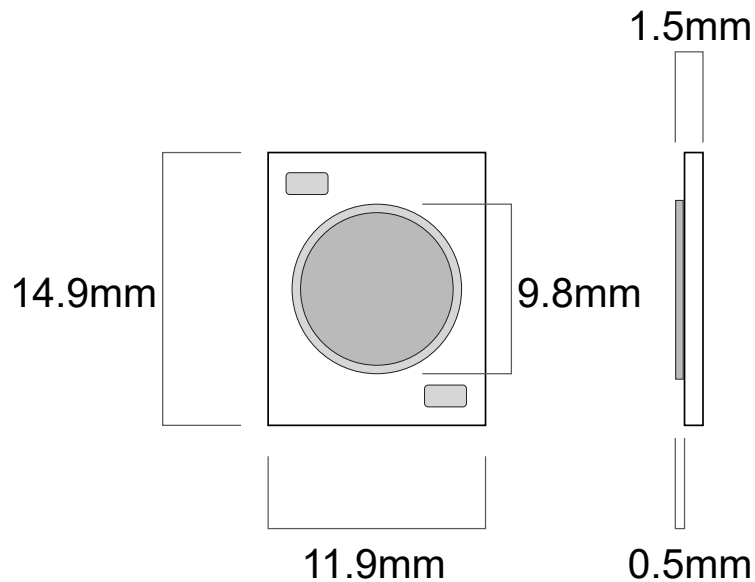

US Patent
#10297584



L.T.F.

High CRI Chip on Board LED

**COBi 1512 12W Single CCT COB
QLUXCOBI15129030 & QLUXCOBI15129027**



PACKAGING INFORMATION

