



L.T.F.

High CRI Chip on Board LED

COBi 1512 12W Platinum Dim-to-Warm COB QLUXCOBI1512903018WD

COBi



Typical Lumens	1225
Typical Wattage	12W
CRI / R9	98 / 95
CCT Range	3000K dim to 1800K
Dimming	CCR; constant current reduction



QLUX COBi mimics the color shift of an incandescent source during dimming by a single phase dimmer. Also available in line voltage models

FEATURES

- Precise light output with no additional need for complicated control system or multiple optics
- Dim-to-Warm; 3000K changes to a cozy 1800K when dimmed
- High color rendering index (CRI) Ra max. 98, R9 95
- LM-80 compliant LEDs
- Tight binning 3 step Mac Adam Ellipses
- Uniform and crisp light source intensity
- Exceeds ENERGY STAR lumen maintenance requirements
- Extra thin low profile
- Low heat generation, easy thermal management
- Easy to fit in new design or retrofit applications

APPLICATIONS

For architectural, residential, hospitality, retrofit, and general lighting fixtures.

- Spot lighting
- Down lighting
- Recessed can lighting
- Ceiling lighting
- Wall sconces
- Table lamps
- Pendants
- Track heads

GENERAL SPECIFICATIONS

Model	Wattage	CCT (No Dim)	CCT (100% Dim)	Ra	Luminous Flux
QLUXCOBI1512903018WD	12W	3000K	1800K	98+	1200*

* at 350mA

CHARACTERISTICS (T_c=25°C)

CCT	Item	Symbol	Condition	Min.	Typ.	Max.	Unit
1800K	Forward Voltage	VF	I =50mA	28	(34.0)	36	V
	Luminous Flux	Φ		116	(134.0)	--	lm
	Chromacity Coordinates	x		--	(0.5357)	--	--
		y		--	(0.4160)	--	--
	General Color Rendering Index	Ra		81	(85)	--	--
3000K	Forward Voltage	VF	I =350mA	31	(35)	39	V
	Luminous Flux	Φ		1013	(1150)	--	lm
	Chromacity Coordinates	x		--	(0.4338)	--	--
		y		--	(0.4030)	--	--
	General Color Rendering Index	Ra		98	(96)	--	--



COBi Photometric Parameters*	
Luminous Flux:	≈ 1200 lm
Radiant Power:	1790 mW
Efficacy:	≈ 82 lm/W

* Test result shown based on 3000 CCT

CRI TEST RESULTS - 3000K

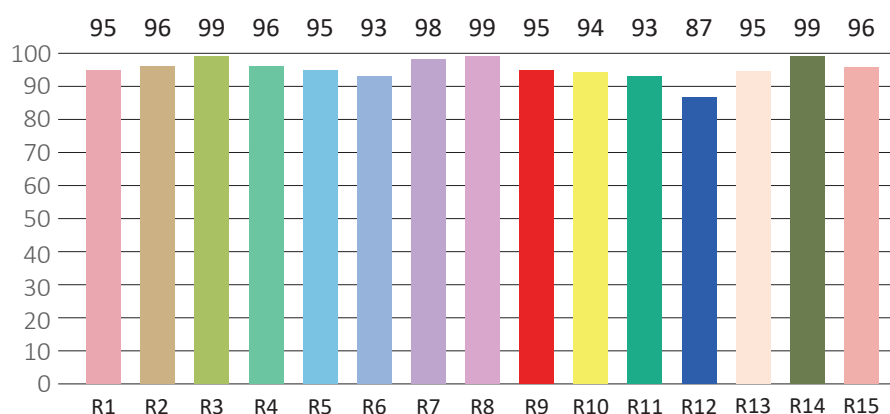

R1=95	R2=96	R3=99	R4=96	R5=95	R6=93	R7=98	R8=99
R9=95	R10=94	R11=93	R12=87	R13=95	R14=99	R15=96	

* Test result shown based on 3000 CCT

CRI TEST RESULTS - 1800K

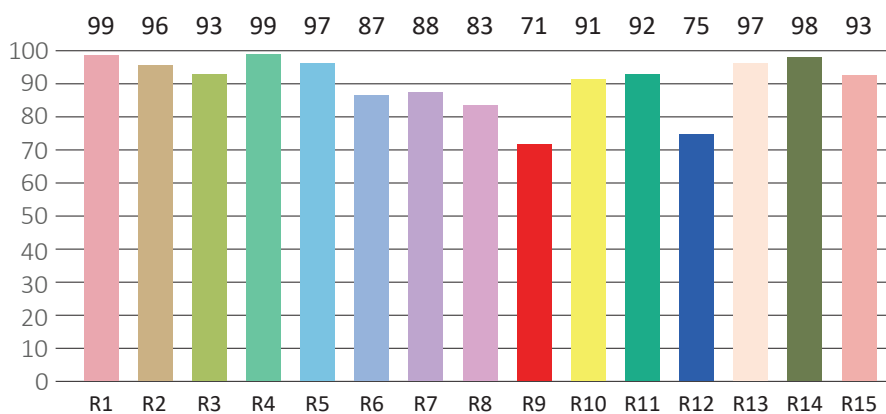

R1=99	R2=96	R3=93	R4=99	R5=97	R6=87	R7=88	R8=83
R9=71	R10=91	R11=92	R12=75	R13=97	R14=98	R15=93	

* Test result shown based on 1800 CCT



SPECTRORADIOMETRIC CHARACTERISTICS AT 3000K

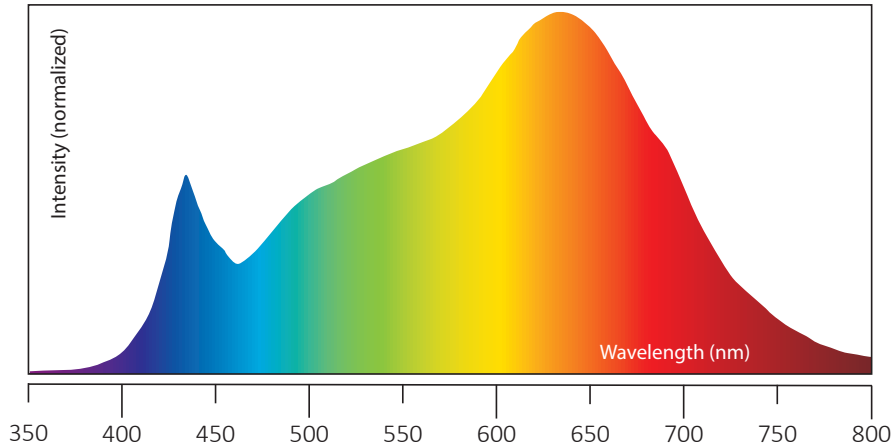

SPECTRORADIOMETRIC CHARACTERISTICS AT 1800K

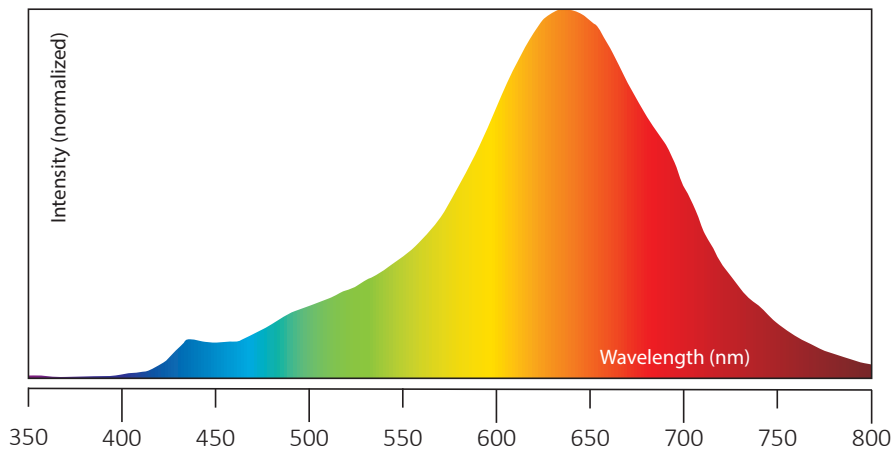

CIE Colorimetric Parameters*	
Chromaticity Coordinates	x=0.4338 y=0.4030
CCT	3052K
Peak Wavelength	635 nm
Dominant Wavelength	582 nm
Rendering Index	96.4
Color Ratio	R=42.8%, G=47.6%, B=9.6%
Half Bandwidth	177.8 nm
Color Purity	0.4443

* Test result shown based on 3000 CCT



ABSOLUTE MAXIMUM RATINGS (Ta=25°C)

	Symbol	Absolute Maximum Rating	Unit
Forward Current	If	420	mA
Peak Power	P	16.9	W
Reverse Voltage	vr	-15	V
Operating Temperature	TOPR	-30~+100	°C
Storage Temperature	Tstg	-40~100	°C
Hand soldering condition	Tsld	3.5sec@350°C	sec
Case Temperature	Tc	100	°C
LED Junction Temperature	Tj	125	°C
Temperature of central silicon surface	Ts	125@IRDA Test	°C

**FORWARD CURRENT
VS. FORWARD VOLTAGE**

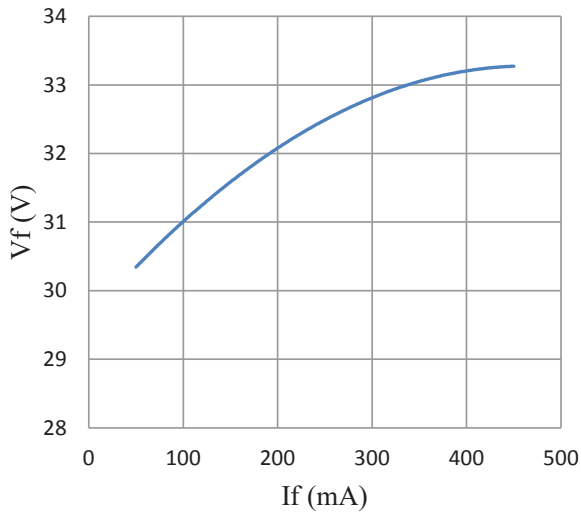

**FORWARD CURRENT
VS. RELATIVE LUMINOUS FLUX**

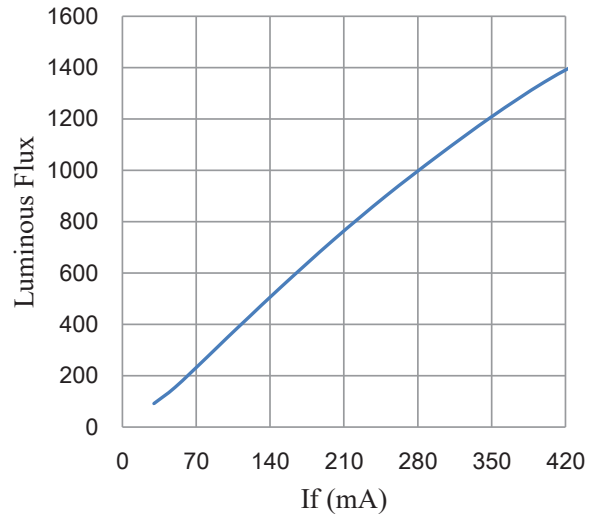



L.T.F.

High CRI Chip on Board LED

**COBi 1512 12W Platinum Dim-to-Warm COB
QLUXCOBI1512903018WD**



TYPICAL SPACIAL DISTRIBUTION

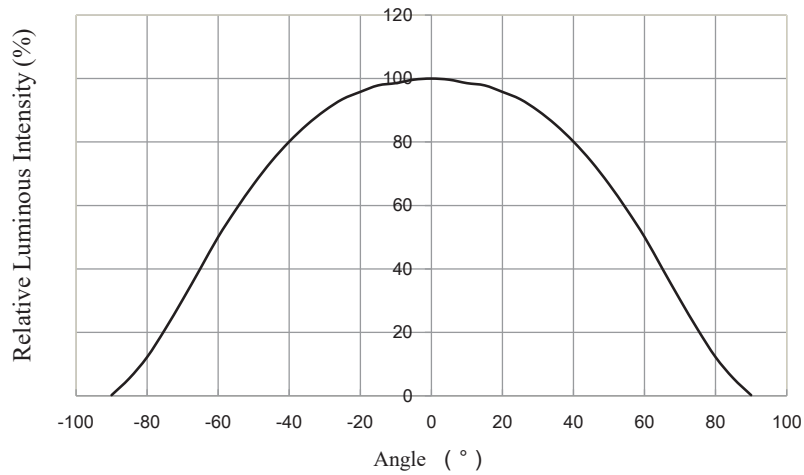

MECHANICAL SPECIFICATIONS

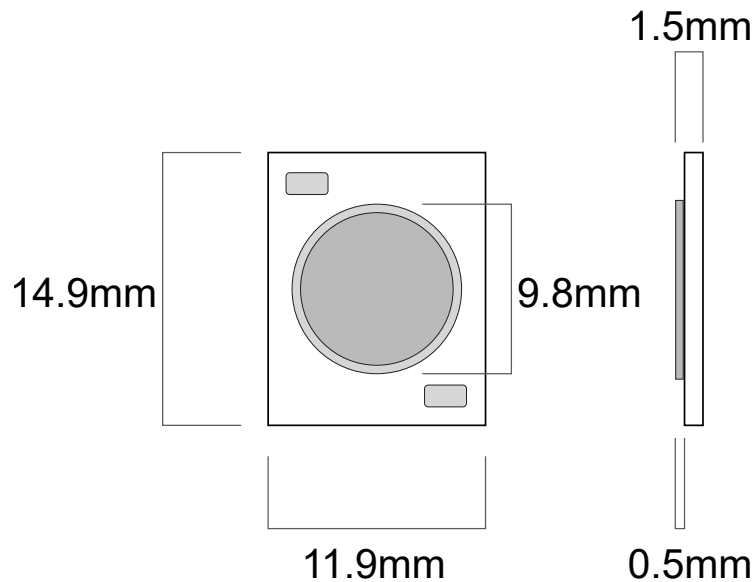

**INTELLECTUAL PROPERTY
PATENT PENDING**



COMPATIBLE LED DRIVERS

Line Voltage LED Drivers					
Model #	Input Voltage	Input Current	Output Voltage	Output Current	Dimming
DA15W350C1042-3001	120V AC 50/60Hz	0.125	10-42V DC	350mA	Triac/ELV
DA15W350C1842D010	120V AC 50/60Hz	0.125	18-42V DC	350mA	Triac/ELV/ 0-10V
DE15W350C1842D010	277V AC 50/60Hz	0.054	18-42V DC	350mA	Triac/ELV/ 0-10V
DS15W350C1042UD	100-305V AC 50/60Hz	0.15	18-42V DC	350mA	Triac/ELV/ 0-10V

Low Voltage LED Drivers				
Model #	Input Voltage	Input Current	Output Voltage	Output Current
DL115W350C	12V AC/DC 50/60Hz	0.05 A	18-42V DC	350 mA
DL215W350C	24V AC/DC 50/60Hz	0.05 A	18-42V DC	350 mA

PACKAGING INFORMATION

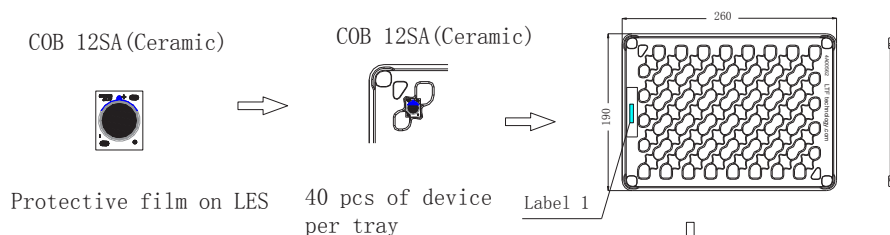

6 trays in an anti-static bag, with one empty tray on top. The set of 6 trays is packed up with a vacuum bag.

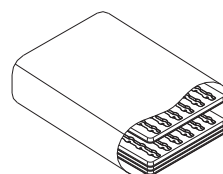

7 bags per box ↓

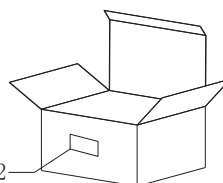

Label 2
1400 pcs of device per box

Notes:
Remove the protective film before use in the first time.